

SI1101 • SI1102 • SI1103

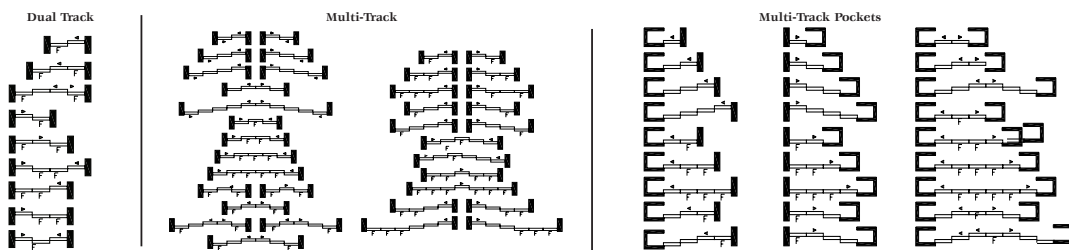

SI1100 series aluminum framed mesh insect screen. Extruded aluminum frame with fiber glass corners for added strength. Multiple operation types for commercial and residential applications.

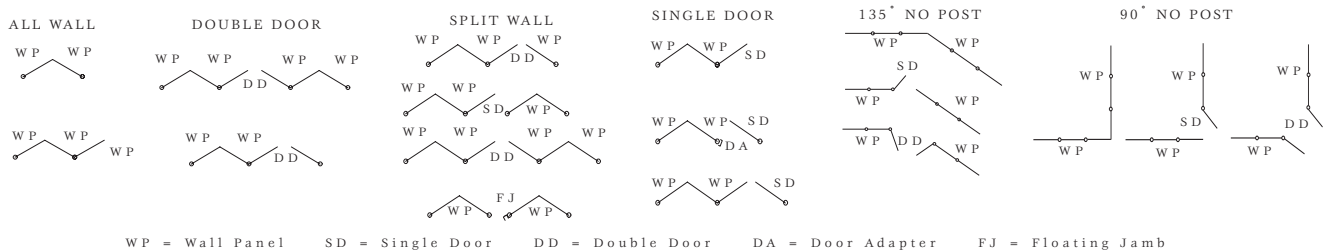

Features:

- Operations: folding, swing, sliding (multi-track)
- Maximum panel size
 - Folding 4' x 10'
 - Sliding 6' x 12' (with mullion support)
- Folding Glass Wall hinges
- Standard Finishes
 - Duracron: Hartford Green, Bronze, Black, Natural Clay, White, Sandstone
- Mesh insect screen material, pet screen options

Options:

- Oversized panels upon request
- Custom finishes
 - Class I anodized: Dark Bronze, Clear
 - Powder coat finish: AAMA 2604-05
 - Fluoropolymer: 50% or 70%
 - Cladding options
 - Dual color or dual finish options
- Drain sills available
- Folding screens with integrated swing doors



SI1101 • SI1102 • SI1103

Folding Screen

1 1/4"

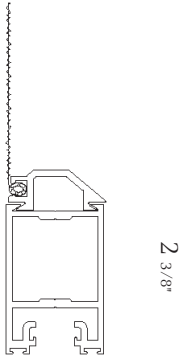

Standard Sliding Screen

1 1/4"

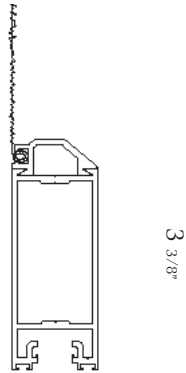

Single Door

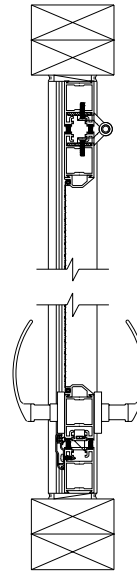

Swing Door

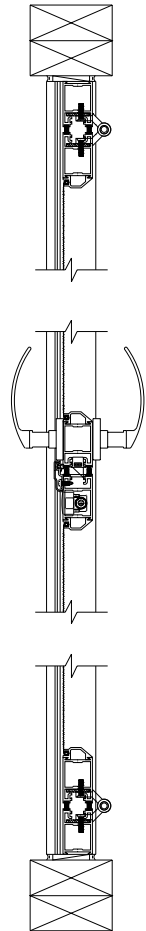

Head and Sill



Head and Sill

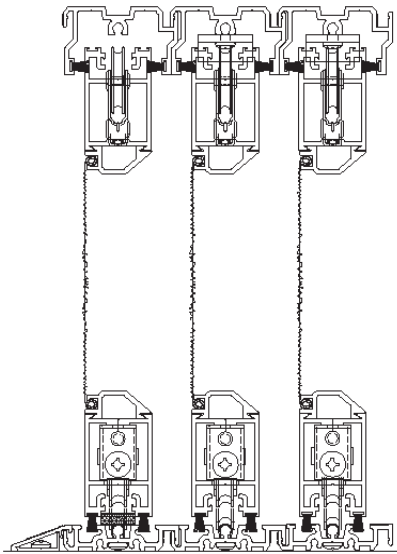

Jamb

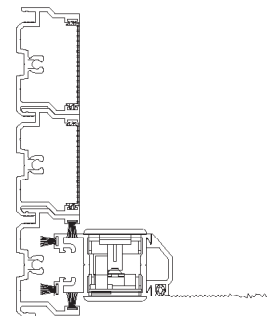

Jamb

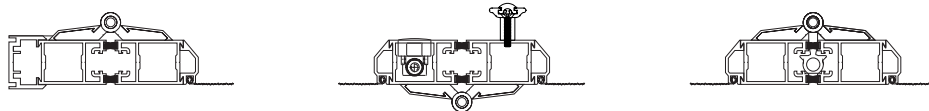

Please be sure to visit our website for additional product information.
www.solarinnovations.com

